



NTSC U/C

PlayStation



SLUS-01457



# The Italian Job™



**WARNING: READ BEFORE USING YOUR PLAYSTATION® GAME CONSOLE.**

A very small percentage of individuals may experience epileptic seizures when exposed to certain light patterns or flashing lights. Exposure to certain patterns or backgrounds on a television screen or while playing video games, including games played on the PlayStation® Game console, may induce an epileptic seizure in these individuals. Certain conditions may induce previously undetected epileptic symptoms even in persons who have no history of prior seizures or epilepsy. If you, or anyone in your family, has an epileptic condition, consult your physician prior to playing. If you experience any of the following symptoms while playing a video game – dizziness, altered vision, eye or muscle twitches, loss of awareness, disorientation, any involuntary movement, or convulsions – IMMEDIATELY discontinue use and consult your physician before resuming play.

**WARNING TO OWNERS OF PROJECTION TELEVISIONS:**

Do not connect your PlayStation® Game console to a projection TV without first consulting the user manual for your projection TV, unless it is of the LCD type. Otherwise, it may permanently damage your TV screen.

**USE OF UNOFFICIAL PRODUCT:**

The use of unofficial products and peripherals may damage your PlayStation® Game console and invalidate your console warranty.

**HANDLING YOUR PLAYSTATION DISC:**

- This compact disc is intended for use only with the PlayStation® Game console.
- Do not bend it, crush it or submerge it in liquids
- Do not leave it in direct sunlight or near a radiator or other source of heat.
- Be sure to take an occasional rest break during extended play.
- Keep this compact disc clean. Always hold the disc by the edges and keep it in its protective case when not in use. Clean the disc with a lint-free, soft, dry cloth, wiping in straight lines from center to outer edge.

Never use solvents or abrasive cleaners.



# *The Italian Job*

## Contents

GETTING STARTED .....	2
INTRODUCTION .....	4
CONTROLLING YOUR CAR .....	5
MENU CONTROLS .....	5
MAIN MENU .....	6
THE ITALIAN JOB MODE .....	6
LAW AND DISORDER .....	7
PARTY PLAY MODE .....	7
OPTIONS .....	8
CHALLENGE MODE .....	9
FREE RIDE .....	10
CHECKPOINT MODE .....	10
DESTRUCTOR MODE .....	11
HINTS AND TIPS .....	11
CREDITS .....	12
MAPS .....	14



## Getting Started

1. Set up your PlayStation according to the instruction manual.
2. Insert the "Italian Job™" DISC and close the disc cover.
3. Turn the PlayStation ON at the POWER button.

**NOTE:** It is advised that you do not insert or remove peripherals or MEMORY CARDS once the power is turned on, so if you wish to save your game, ensure there is 1 free block on your MEMORY CARD before commencing play.

Top view

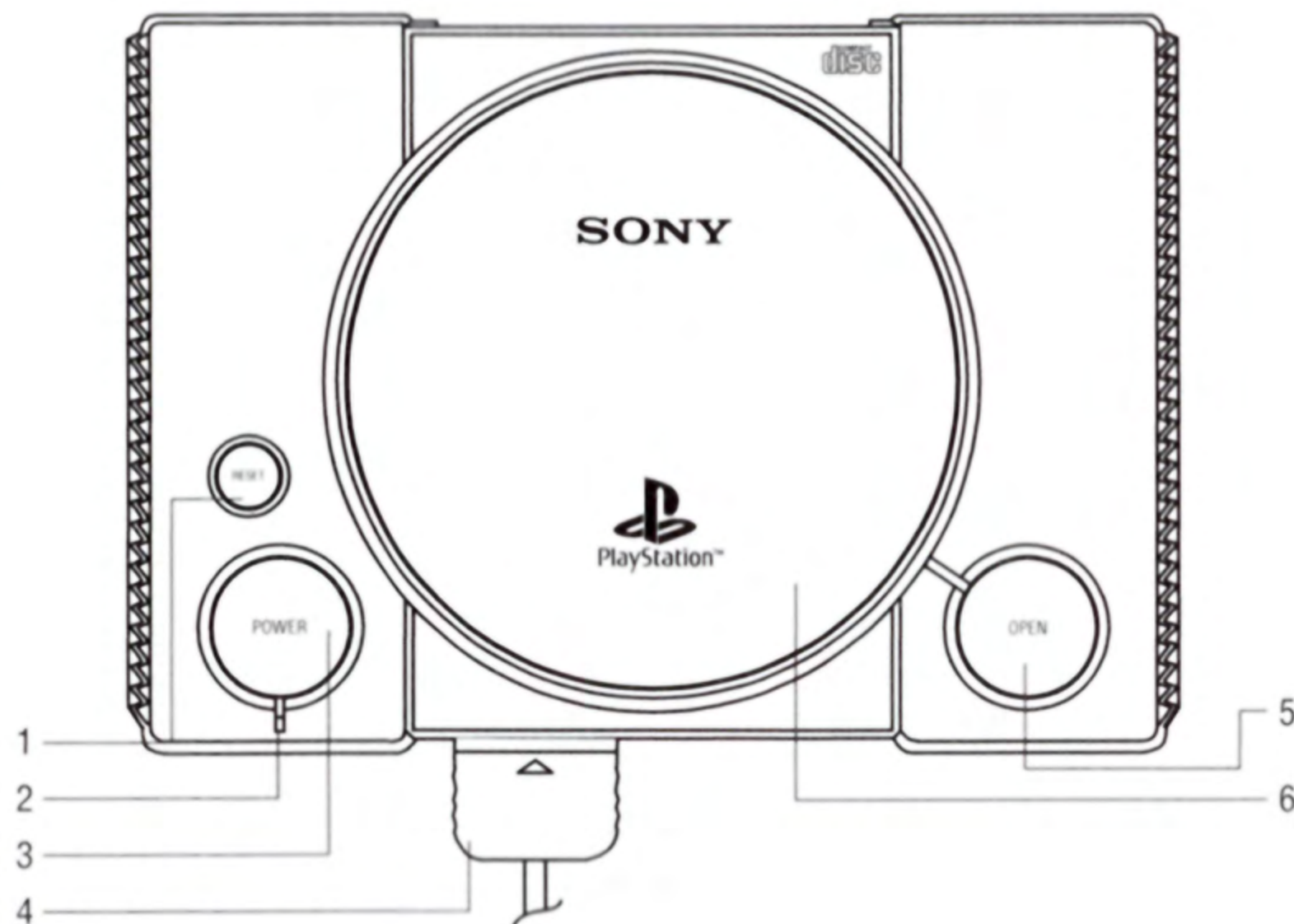

Front view

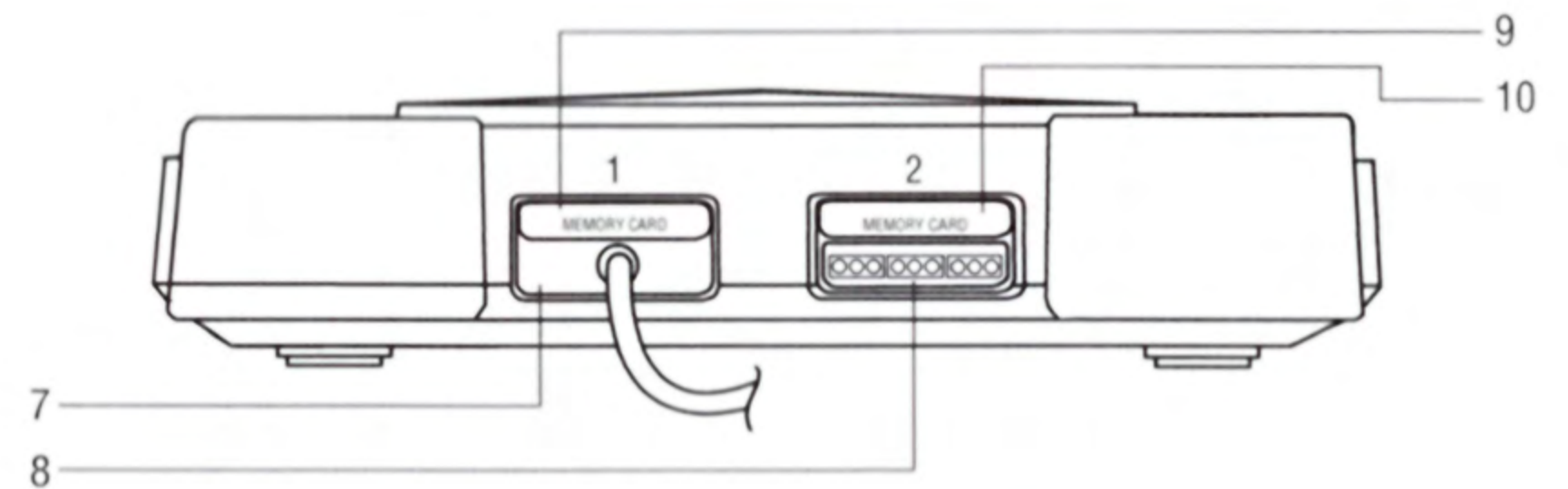

- 1 RESET button
- 2 POWER indicator
- 3 POWER button
- 4 Controller port
- 5 OPEN button

- 6 disc cover
- 7 Controller port 1
- 8 Controller port 2
- 9 MEMORY CARD slot 1
- 10 MEMORY CARD slot 2

# DUALSHOCK® analog controller

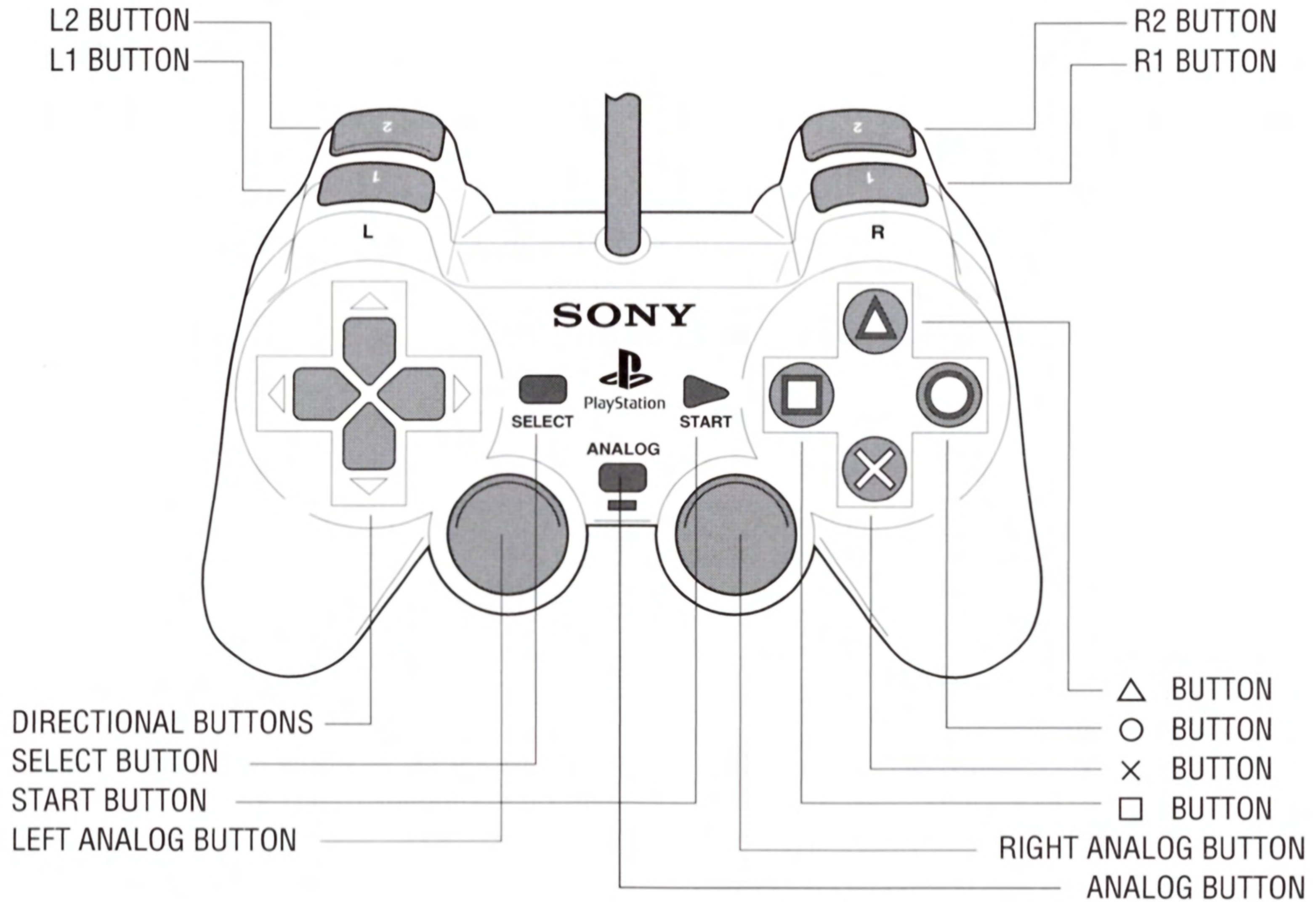



## Introduction:

**“Hang on a minute, lads. I’ve got a great idea.....”**

In 1969 the film ‘The Italian Job’ was released in the UK and almost immediately achieved cult status. Over the last 30 years it has become almost legendary, securing its place in history as one of the all time great British movies.

The film revolves around Charlie Croker, who is out of jail and on the make again. This time, he is attempting to steal \$4,000,000 worth of gold in broad daylight and from under the noses of the Turin Police and the Mafia. To do this, he must get together a gang of the best crooks in London, create the biggest traffic jam Turin has ever witnessed and escape through the resulting chaos - up for it? Well, if you are, then PlayStation owners now have the chance to do the same thing in this amazing new driving game. Using continuous streaming technology, you will get to play in truly massive environments - London and Turin. Finally, you’ll have to try and make your escape over the windy, narrow roads of the Alps.

Only the best have a chance to win....Only the best will make it a return trip.

## The Characters:



**Charlie Croker** - the gang leader.  
A lovable rogue who never quite gets it right.



**Mr. Bridger** - the gangland boss and money behind the ‘job’. Loves the Queen and Britain and is only doing the job to help with the balance of payments - honest!



**‘Camp’ Freddie** - Mr. Bridger’s liaison.  
Not going to run off with your girlfriend .....



**Professor Simon Peach** - a computer genius with a weakness for big women ..... VERY big women.



**Lorna** - Charlie’s girlfriend. Always makes sure that Charlie gets the best in life.



**Roger Beckerman** - the Italian who first came up with the idea.

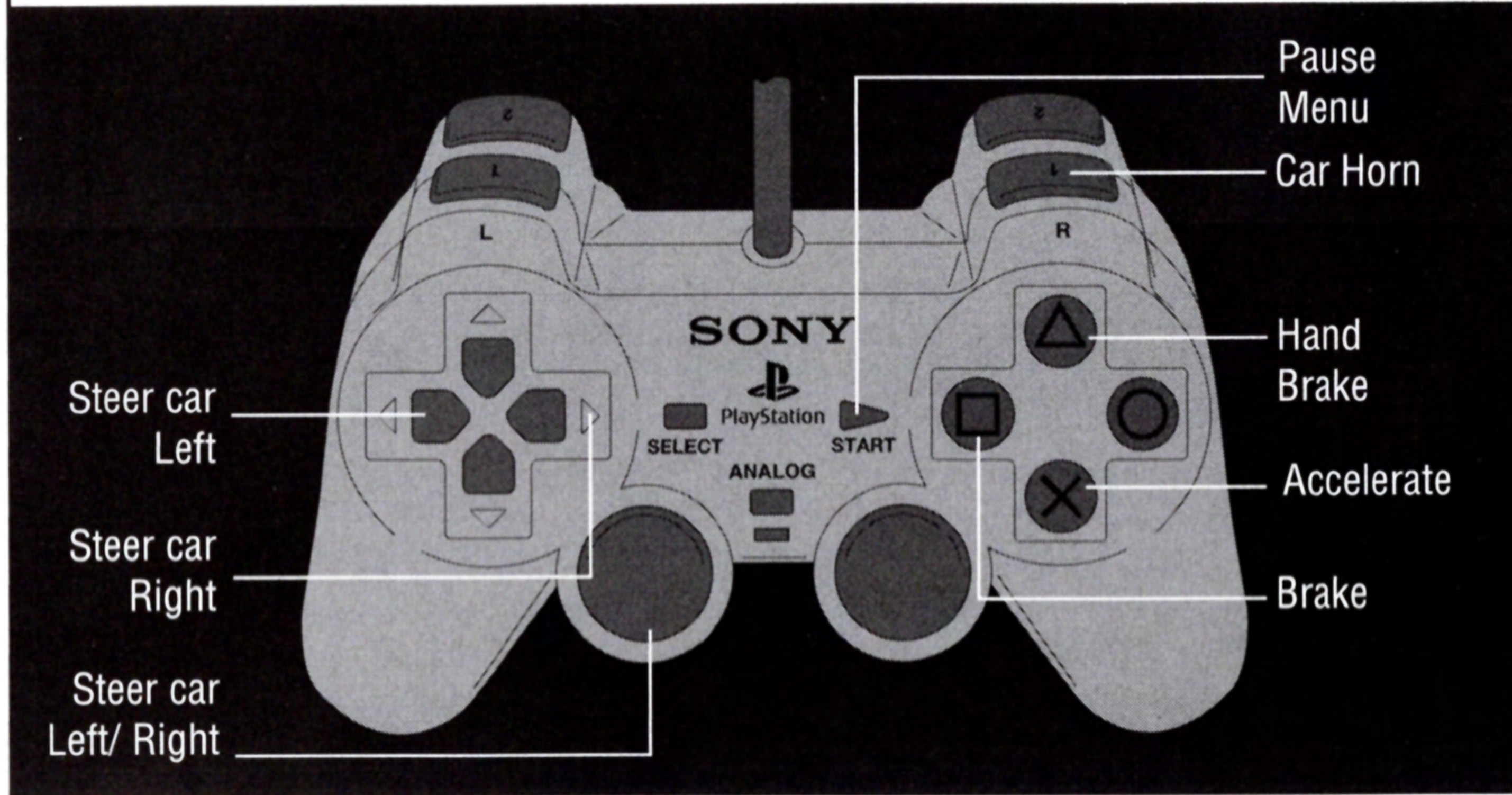

## Controlling Your Car



### **DUALSHOCK® Analog Controller Support**

The vibration function can be toggled on or off in the Controller Setup section of the OPTIONS menu.

### **Menu Controls**

On all of the menu and selection screens you can use LEFT and RIGHT on the directional button to highlight your choice, then press the  button to verify its selection. If you press the  button at any time you will be returned to the previous menu.



## Main Menu

By pressing LEFT or RIGHT on the directional button you can highlight any of the seven menu items:

**ITALIAN JOB MODE:** This is the main game story mode.

**PARTY PLAY:** Select this to play in a series of car trials with up to seven friends.

**OPTIONS:** This will allow you to adjust the game's setup.

**CHALLENGE MODE:** Unlock this mode to test your single player driving skills.

**FREE RIDE:** Want to drive around London and Turin, taking in the sights at your leisure? Then try this mode.

**CHECKPOINT MODE:** Scream around the streets of London and Turin in the ultimate test of slalom skill.

**DESTRUCTOR MODE:** Are you a Cone Killer? Chase down all of the road cones before the time runs out.

## Italian Job Mode

Italian Job Mode is where you get to play the part of lovable rogue Charlie Croker and his gang as they get together all of the people and equipment they need to pull off a raid as daring as the Italian Job. As you work your way through the game, from London to Turin and finally to the Alps, you will open up new cars for you to drive in Free Ride Mode and new trials for you to conquer in Challenge Mode, Checkpoint Mode and Destructor Mode.



## Choosing Your Mission

To play "The Italian Job" mode you must first select one of the missions from this screen. The screen shows the three sections of the game: London, Turin and The Alps.

The first time you come to this screen only one of the missions will be unlocked for you to play, the rest are marked with an enigmatic . Press LEFT and RIGHT on the directional button to move between the available missions to play and then press the button to confirm your choice. As you complete each mission, more will be unlocked and become accessible through this screen. As each mission is unlocked more Checkpoint races, Destructor races and Challenges also become available, so keep a lookout in the other menus. Remember that, as you make your way through the game, the only way to save your progress is to ensure that before you turn on your PlayStation you have a MEMORY CARD inserted into MEMORY CARD slot 1 or MEMORY CARD slot 2 with at least 1 free block available.



## The Briefing Screen

Once you have selected which part of The Italian Job you want to play, you will be taken to the secret conference room where you'll be briefed by top dog Charlie Croker. Listen carefully to what Charlie has to say, he's a smart guy and it could mean the difference between getting that \$4,000,000 in gold bullion or ending up being served spaghetti by a man named Antonio every day for a ten year stretch.

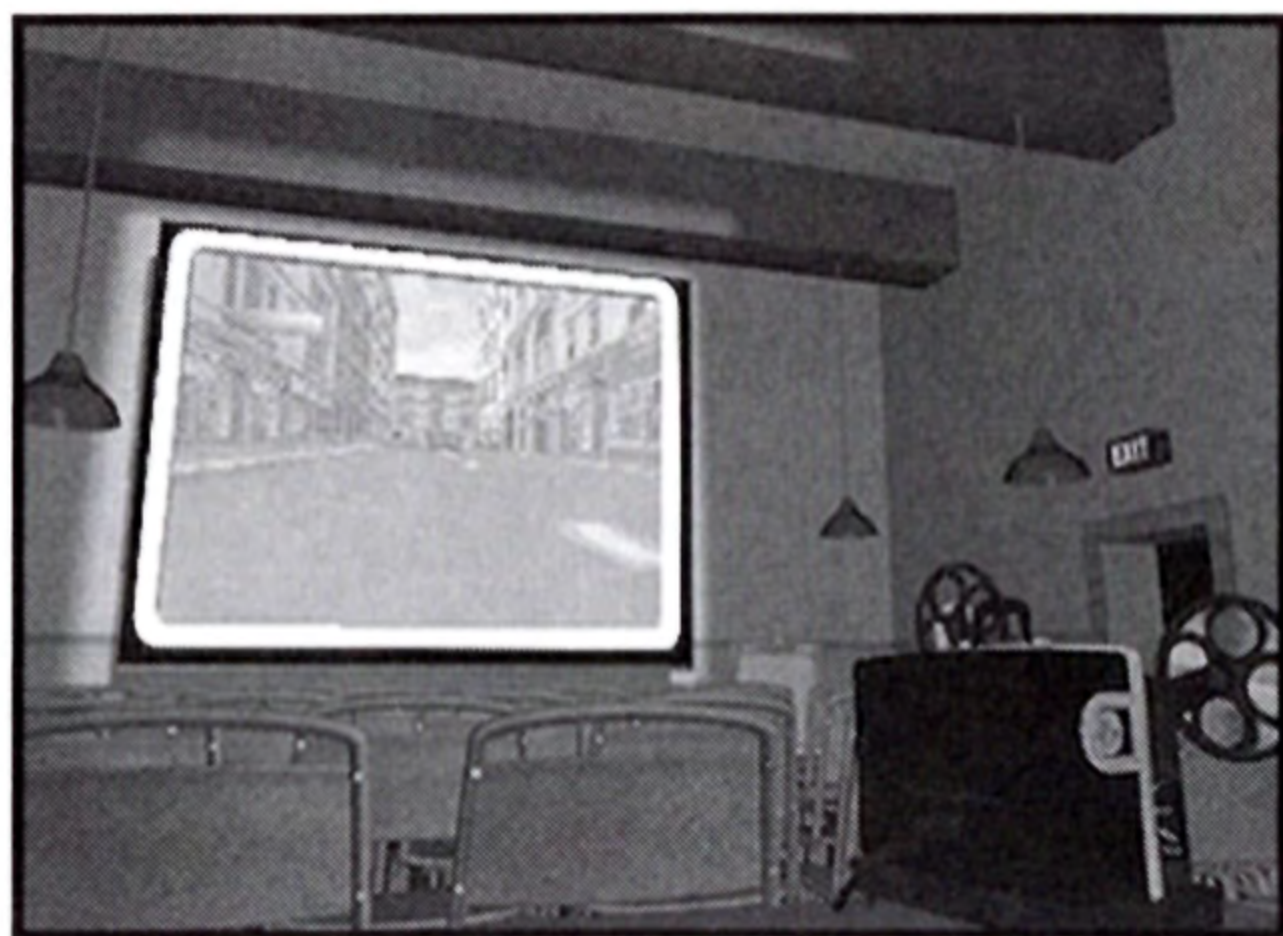

You can skip the briefing screen at any time by pressing the **X** button.

## Playing the game

To complete The Italian Job, you will have to drive many different vehicles and take part in a huge variety of missions ranging from picking up your gangland benefactor's right hand man to transporting explosives in a particularly rickety old coach. Sometimes you'll have to stick to the rules of the road and sometimes you'll have to use every trick in the book to evade the Police.

One thing you'll have to remember is that every collision damages your car and adds to your damage meter (found at the top left hand corner of the screen). Should your damage meter fill up, your car will be wrecked and your chances of pulling off The Italian Job will be ruined.

## Finding your way around

Navigating your way around big cities like London and Turin can be a real challenge. Fortunately much of the time during gameplay you'll be pointed in the right direction by the very helpful Italian Job Arrow. However, if you want to find all of the sneaky shortcuts and quickest routes through the bustling metropolises you really want to carefully study the maps printed at the back of the manual.

## Law and disorder

Life's not fair, and taking part in the Italian Job will sometimes bring you to the attention of the police. When they give chase, you will hear the sirens behind you and see the speedo flashing at the bottom of the screen; the bigger the triangle, the closer they are. If the Police get too close they'll read your number plate and once they get the whole thing then the game is over.

## The Mafia

The Mafia, on the other hand, generally don't abide by the law. If you encounter these creeps in Turin they will do their best to ram you off the road and send you packing back to England.

**NOTE:** You may pause the game, return to the main menu, retry the current mission or refresh your memory with the current objectives simply by pressing the START button at any time during gameplay. Pressing the START button again will return you to the game.

## Party Play Mode

Party Play Mode lets up to seven people take part in a competition to determine just who is the king of the road. Once you have selected Party Play Mode from the main menu you will be asked to select the number of players who will take part in the Party Play challenge.



Press LEFT and RIGHT on the directional button to select the number of players and then press the **X** button to confirm your choice. Now use the same method to select the number of games you wish to play.

Once you have selected the number of games to play, you will be presented with a bar on the screen. The bar contains icons representing all of the Challenge, Checkpoint and Destructor games available in Party Play mode. Navigate the different game icons by pressing LEFT and RIGHT on the directional button and move between Challenge, Checkpoint and Destructor modes by pressing UP and DOWN on the directional button. When you have found the game you want to play just press the **X** button and the icon will be transferred into your customized game bar in the middle of the screen. By using this method you can pick and choose up to ten different Challenge, Checkpoint or Destructor games for you and your friends to play.

## Options

### Adjust Screen Position

Use UP, DOWN, LEFT and RIGHT on the directional button to adjust the position of the display on your screen. Press the **X** button to confirm the changes, or press the **△** button to return to the previous menu.

### Controller Setup

There are three different Controller layout options in the



Italian Job. To change the Controller layout from the default, press LEFT or RIGHT on the directional button so that the selection 'LAYOUT' appears in the menu bar at the bottom left hand corner of the screen, then press the **X** button. Pressing LEFT or RIGHT on the directional button will now change the layout, while pressing the **X** button will confirm the new Controller settings.

If you have a DUALSHOCK® analog controller then you can toggle the vibration function On and Off by pressing LEFT or RIGHT on the directional button so that the selection 'VIBRATION' appears in menu bar at the bottom left hand corner of the screen and then pressing the **X** button. Now press LEFT or RIGHT on the directional button to move between ON and OFF, and press the **X** button to select your new setting.

The NeGcon® controller is supported by The Italian Job. You can calibrate this device by entering the Controller Setup menu and following the on-screen instructions. Steering wheels with a NeGcon® compatible playing mode can also be calibrated in this menu; however, after playing each level you must return the Wheel to NeGcon® mode. Please refer to your Steering Wheel manual for instructions on how to do this.

### Difficulty Mode

There are two difficulty modes in The Italian Job. Choose this option and then press LEFT or RIGHT on the directional button so that the selections "Easy" or "Normal"

appear in the menu bar at the bottom left hand corner of the screen, then press the **X** button to confirm your choice.

### **Save**

You can save your progress at any time in the game by returning to the main menu (you can do this by pressing the **△** button while you are in the mission select screen or by pressing the START button during gameplay to bring up the Pause menu, then select the QUIT option) and selecting OPTIONS and then SAVE.

You will be presented with a picture of two MEMORY CARDS. The picture of the MEMORY CARD on the left of the screen represents the MEMORY CARD in MEMORY CARD slot 1, while the picture of the MEMORY CARD on the right of the screen represents the MEMORY CARD in MEMORY CARD slot 2. If the MEMORY CARD has an **X** symbol over it, this means there is no valid MEMORY CARD in that particular MEMORY CARD slot.

You may highlight a MEMORY CARD for use by using LEFT and RIGHT on the directional button. Pressing the **X** button will start the saving process. Now follow the on-screen prompts to save your game.

**NOTE:** Before powering on your PlayStation, you must have inserted a MEMORY CARD in MEMORY CARD slot 1 or MEMORY CARD slot 2 with at least 1 free block on it in order for this facility to function correctly.

### **Load**

Select the OPTIONS menu and then the LOAD menu. You will be presented with a picture of two MEMORY CARDS; The picture of the MEMORY CARD on the left of the screen represents the MEMORY CARD in MEMORY CARD slot 1, the picture of the MEMORY CARD on the right of the screen represents the MEMORY CARD in MEMORY CARD slot 2. If the MEMORY CARD has an **X** symbol over it, this means there is no valid MEMORY CARD or valid save game in that particular MEMORY CARD slot.

You may highlight a valid MEMORY CARD for use by

using LEFT and RIGHT on the directional button. Pressing the **X** button will instigate the loading procedure.

Now follow the on-screen prompts to load your game.

**NOTE:** Before powering on your PlayStation, you must have inserted a MEMORY CARD in MEMORY CARD slot 1 or MEMORY CARD slot 2 with a valid Italian Job saved game on it in order for this facility to function correctly.

### **Audio Setup**

When you select this option you will see two dials on the Audio Setup screen. These represent SOUND EFFECTS volume and MUSIC volume. You can move between the two dials by pressing UP and DOWN on the directional button, and change the volume by pressing LEFT or RIGHT on the directional button.

**NOTE:** You can also change the volume of sound effects and music at any time during the game by pressing the START button and moving the highlight down to SFX VOLUME or MUSIC VOLUME. Pressing LEFT or RIGHT on the directional button will then alter the volume setting.

### **Challenge Mode**

Challenge Mode consists of ten tough trials of driving skill, speed and courage. There are exercises in jumping, racing and car control. As you work your way through the Italian Job Mode the Challenge Mode will become unlocked.

### **Choosing the Game Mode**

Press LEFT or RIGHT on the directional button to select one of the ten challenges, then press the **X** button to begin the game.

### **Playing Challenge Mode**

Before you start, you will be given instructions on the nature of the challenge and exactly what you need to do in order to win.



If you wish, at any time during the challenge you may restart by pressing the START button and selecting RETRY from the Pause menu.

## Free Ride

Free Ride mode gives you the opportunity to drive around the beautiful city environments of London and Turin.



As you drive around you'll meet some colorful characters who may offer you a challenge. Have fun and drive safely!

**NOTE:** When you first play Free Ride Mode, only one vehicle and the London map are unlocked. However, as you complete missions in Italian Job Mode, more cars and eventually the Turin map will be unlocked.



## Select Vehicle

Pressing LEFT or RIGHT on the directional button will cycle between all of the cars available. Press the X button to select the currently displayed car and you can then move on to selecting your city.

## Select City

Change between the London and Turin maps by pressing LEFT or RIGHT on the directional button. Pressing the X button will select the currently displayed city and launch you into the game.

## Checkpoint Mode

Checkpoint Mode is a crazy slalom race through city streets, Italian Job style.

## Selecting a Checkpoint Race

Although 19 of the races are initially unavailable, once unlocked you can press LEFT or RIGHT on the directional button and select from any of the twenty challenges, then press the X button to begin the game.

## Playing Checkpoint Mode

Before you start you will be given instructions on the nature of the challenge and exactly what you need to do in order to win.

If you wish, at any time during the challenge, you may restart by pressing the START button and selecting RETRY from the Pause menu.

## Destructor Mode

Ever wanted to mow down those lines of cones bordering all road works? Well, Destructor Mode is a dream come true. Lines of cones snake through the city streets, just begging you to come and show them your front bumper.



### Selecting a Destructor Race

Although 19 of the races are initially unavailable, once unlocked you can press LEFT or RIGHT on the directional button and select from any of the twenty challenges, then press the **X** button to begin the game.

### Playing Destructor Mode

Before you start you will be given instructions on the nature of the challenge and exactly what you need to do in order to win. If you wish, at any time during the challenge, you may restart by pressing the START button and selecting RETRY from the Pause menu.

### Hints And Tips

**STUDY THE CITY MAPS CAREFULLY** – they'll show you all of the short cuts you can use to trim valuable seconds off your mission times.

**PRACTICE IN FREE RIDE MODE.** There is no time limit here so you can spend hours admiring the scenery and developing tactics for each mission.

In London cars drive on the left, in Turin they drive on the right. Remember to stick to the correct side of the road and avoid on-coming traffic.

**ALTERNATIVE ROUTES.** Try alternative routes to avoid Police or Mafia cars.

**LINE UP YOUR CAR BEFORE ATTEMPTING ANY JUMPS** – only an expert turns while jumping - though this skill may be useful later in the game.

**CORNERS.** Take as many corners as possible to lose the Police or the Mafia.

**THE SHORTEST ROUTE** – is not necessarily the best route.

# Credits

## For Sci

**CHIEF EXECUTIVE**

**DEVELOPMENT MANAGER**

**CREATIVE DEVELOPMENT MANAGER**

**PRODUCER**

**ASSOCIATE PRODUCER**

**QA MANAGER**

**LEAD QA**

**QA TEAM**

**LICENSING**

**SCI SALES & MARKETING TEAM**

**PR**

**ADMINISTRATION**

**OPERATIONS & PRODUCTION**

**FINANCE**

**LEGAL**

Jane Cavanagh

Darren Barnett

Patrick O'Luanaigh

Peter Hickman

Ben Gunstone

Marc Titheridge

Dave Isherwood

Luigi Fusco

Ben Mason

Carl Perrin

Matt Friday

Joe Best

Joseph Pirocco

Simon '007' Hewitt

Bill Ennis

Dave Clark

Keith Hodgetts

Jacy Lamb

Chris Mehers

Chris Walton

Ray Livingston

Justyna Cielecki

Patrick Short

Sam 'Mungo' Forrest

Andy Judd

Katie Blundell

Fern Robertson

Jessica Bradford

Helen Clark

Nicole Beale

Jon Wild

Rob Murphy

Jennie Taylor

Ian Chapman

Matthew Freeman

Jo Tidy

**MUSIC/ SOUND EFFECTS**

**VOCAL DIRECTOR**

**VOCAL TALENT**

**FOR PAXELOGIC**

**DIRECTOR**

**LEAD PROGRAMMER**

**LEAD ARTIST**

**LEAD DESIGNER**

**ARTIST**

**ARTIST**

**ARTIST**

**PROGRAMMER**

**DESIGNER**

**FOR AUDIO MOTION**

**CREATIVE DIRECTOR**

**STORYBOARDS**

**HEAD ARTIST**

**ANIMATORS**

**AUDIO**

**POST+EDIT**

**TECHNICAL ADVISORS**

**FOR PARAMOUNT**

**DIRECTOR, PRODUCT DEVELOPMENT**

**- INTERACTIVE & TECHNOLOGY**

**SUPERVISOR, PRODUCT DEVELOPMENT**

**-INTERACTIVE & TECHNOLOGY**

Allister Brimble

Will Davis

Phil Morris

David Coker

Laurel Lefkow

Phil Cornwell

Bryan Reynolds

Chris Butler

Richard Richter

John Li

Robin Ball

Simon Beal

Ian Shepherd

Robin Mangham

Kris Gormley

Terry Hylton

Neil Maguire

Bryn Williams

Ilyas Kaduji

Martin Lanzinger

Mark Wallman

Des Tong

Steve Garratt

Grant Holdsworth

and The London Mini Centre

Harry Lang

Dan Felts

## **FOR ROCKSTAR GAMES N.Y.**

### **PRODUCER**

Matthew Kreager

**LOCALIZATION PRODUCERS** Adam Davidson, Brandon Rose

**TECHNICAL SUPPORT SUPERVISOR** Sydney F. Saunders IV

**TECHNICAL SUPPORT** Matthew Baros, Patty Saneman,  
Katie Young, Andre Liggins, Alex Bradley,  
Mykl Ranere, Dave Thomas, Stacey Sharpe

**QA SUPERVISER** Frank Kirchner

**QUALITY ASSURANCE** Charles Franklin, Ben Hamel, Daniel  
Karp, Lisa Nawrot, Josh Noll, Josh Rose, Jonathan Stephan,  
Stephen Thomas, Scott Vail, Roger Levy, Greg Peeler

**ROCKSTAR PRODUCTION TEAM** Jennifer Kolbe,  
Laura Paterson, Stanton Sarjeant, Chris Carro,  
Jamie Leece, Terry Donovan

## **SPECIAL THANKS TO ROCKSTAR QA**

### **Special Thanks To:**

#### **(FOR SCI)**

Jon 'Jonnyboy' Court  
Matthew Miles 'Gridbug' Griffiths  
Lee 'Guru' Singleton

#### **(FOR PIXELOGIC)**

Planet PC  
The families of the staff for their support during the making  
of The Italian Job.

#### **(FOR PARAMOUNT PICTURES)**

Andrea Hein  
Terri Helton  
Pam Newton  
Nancy Bassett  
Mona Metwalli  
Sylvia Cascallar

"It's Caper Time" written by Quincy Jones. Published by  
Famous Music Corporation, Inc., administered by BMG  
Music Publishing Ltd.

"It's Caper Time" recording produced by James Fitzpatrick,  
Copyright 2001 Silva Screen Records Ltd.

The Italian Job Software ©2001 SCi (Sales Curve Interactive)  
Limited. The Italian Job ©2002 Paramount Pictures.  
All Rights Reserved.

Mini and the Mini logo are trademarks of BMW AG and are  
used under license by SCi (Sales Curve Interactive) Ltd.  
©2001 BMW AG.

Published by Rockstar Games. Developed by PixeLogic.  
Licensed by SCi Ltd.

## **Technical Support**

If you have a technical problem concerning the  
operation of our software,  
please contact our technical support staff. .

**TECHNICAL SUPPORT: 1-410-933-9191,  
M-F 9-5PM, EST  
TalonSoft**

**9900 Franklin Square Drive Suite A  
Baltimore, MD 21236**

*If you would like to contact us on-line,  
you will find us at:*

**[www.talonsoft.com](http://www.talonsoft.com)  
E-mail us at [tech@talonsoft.com](mailto:tech@talonsoft.com)**

Note: This information is for technical support only and representatives  
cannot provide game hints or suggestions.

# ***London***

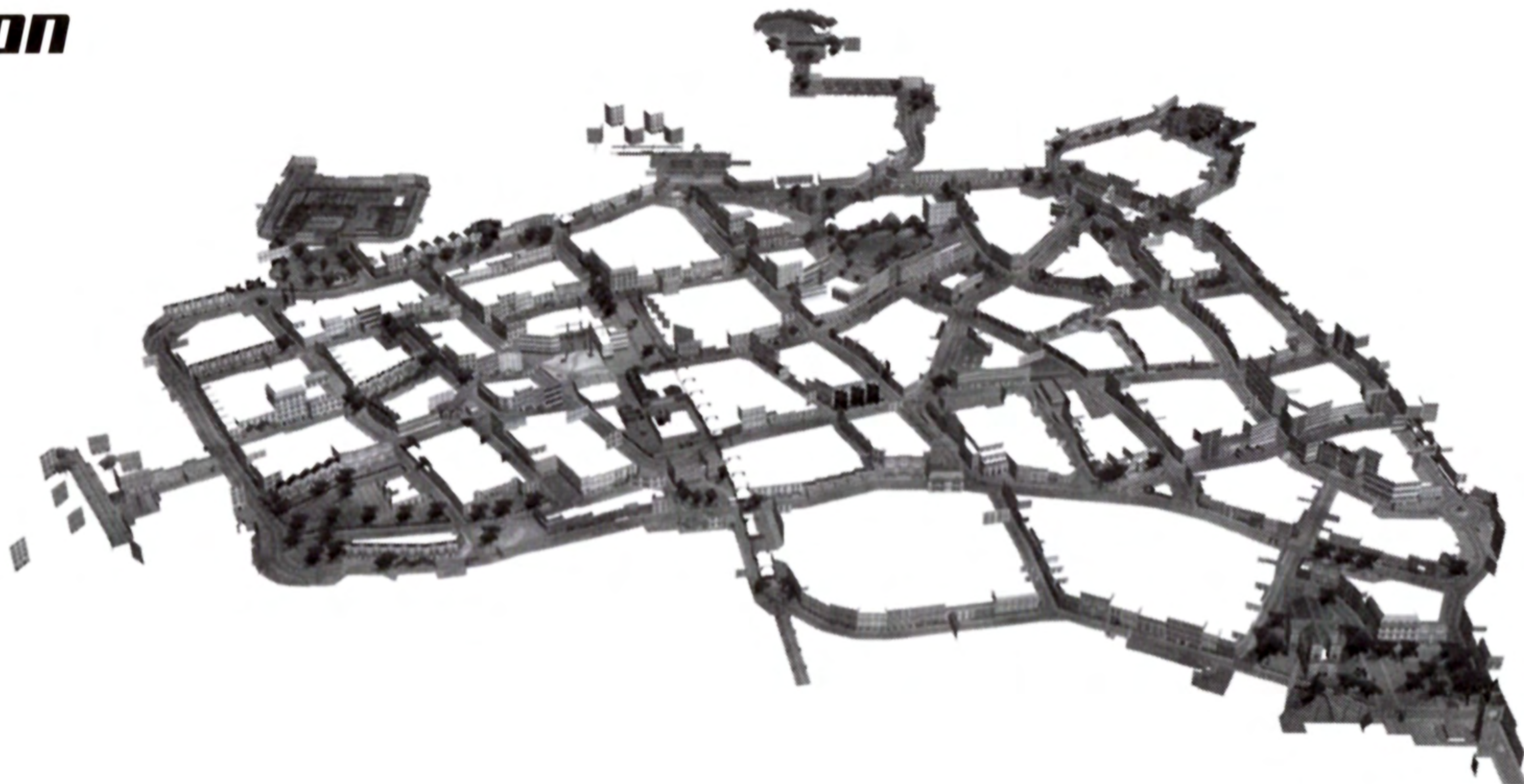

# ***Turin***

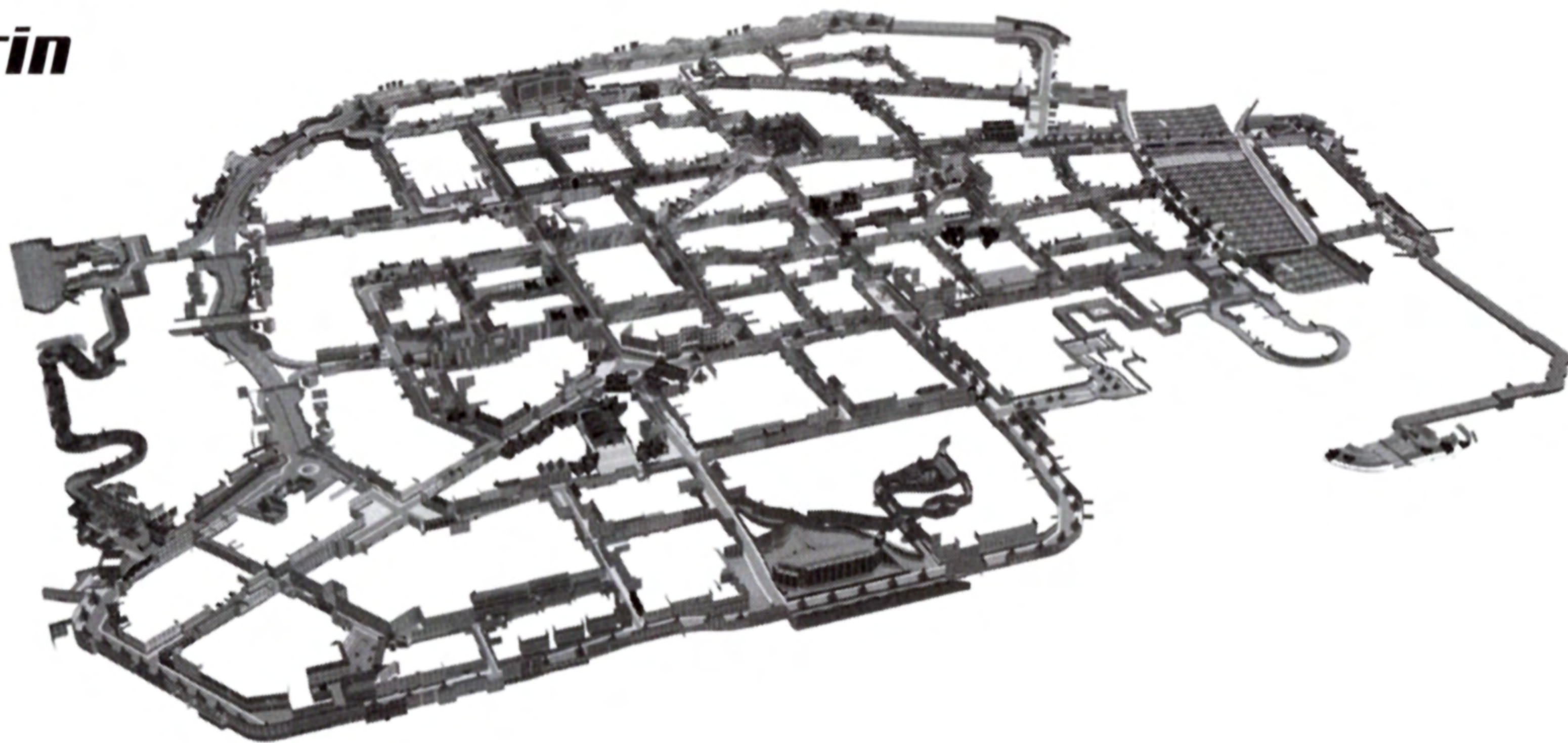



**Notes:**

**Notes:**

# Warranty

ROCKSTAR GAMES, A DIVISION OF TAKE-TWO INTERACTIVE SOFTWARE, INC., WARRANTS TO THE PURCHASER ONLY THAT THE DISC PROVIDED WITH THIS MANUAL AND THE SOFTWARE PROGRAM CODED ON IT WILL PERFORM IN ACCORDANCE WITH THE DESCRIPTION IN THIS MANUAL WHEN USED WITH THE SPECIFIED EQUIPMENT, FOR A PERIOD OF 90 DAYS FROM THE DATE OF PURCHASE.

IF THIS PROGRAM IS FOUND TO BE DEFECTIVE WITHIN 90 DAYS OF PURCHASE, IT WILL BE REPLACED. SIMPLY RETURN THE DISC TO ROCKSTAR GAMES OR ITS AUTHORIZED DEALER ALONG WITH A DATED PROOF OF PURCHASE. REPLACEMENT OF THE DISC, FREE OF CHARGE TO THE ORIGINAL PURCHASER (EXCEPT FOR THE COST OF RETURNING THE DISC) IS THE FULL EXTENT OF OUR LIABILITY.

THIS WARRANTY IS IN LIEU OF ALL OTHER WARRANTIES, WHETHER ORAL OR WRITTEN, EXPRESSED OR IMPLIED. ALL IMPLIED WARRANTIES, INCLUDING THOSE OF MERCHANTABILITY AND FITNESS FOR A PARTICULAR PURPOSE, IF APPLICABLE ARE LIMITED IN DURATION TO 90 DAYS FROM THE DATE OF PURCHASE OF THIS PRODUCT.

ROCKSTAR GAMES SHALL NOT BE LIABLE FOR INCIDENTAL AND/OR CONSEQUENTIAL DAMAGES FOR THE BREACH OF ANY EXPRESS OR IMPLIED WARRANTY INCLUDING DAMAGE TO PROPERTY AND, TO THE EXTENT PERMITTED BY THE LAW, DAMAGES FOR PERSONAL INJURY, EVEN IF ROCKSTAR GAMES HAS BEEN ADVISED OF THE POSSIBILITY OF SUCH DAMAGES. SOME STATES DO NOT ALLOW THE EXCLUSION OR LIMITATION OF ANY INCIDENTAL OR CONSEQUENTIAL DAMAGES OR LIMITATIONS ON HOW LONG AN IMPLIED WARRANTY LASTS, SO THE ABOVE LIMITATIONS OR EXCLUSIONS MAY NOT APPLY TO YOU.

THIS WARRANTY SHALL NOT BE APPLICABLE TO THE EXTENT THAT ANY PROVISION OF THIS WARRANTY IS PROHIBITED BY ANY FEDERAL, STATE, OR MUNICIPAL LAW, WHICH CANNOT BE PRE-EMPTED. THIS WARRANTY GIVES YOU SPECIFIC LEGAL RIGHTS AND YOU MAY ALSO HAVE OTHER RIGHTS, WHICH MAY VARY FROM STATE TO STATE.

YOU MAY NOT REPRODUCE, PREPARE DERIVATIVE WORKS BASED ON, DISTRIBUTE COPIES OF, OFFER FOR SALE, SELL, TRANSFER OWNERSHIP OF, RENT, LEASE, OR LEND TO OTHERS THE PROGRAM OR ACCOMPANYING DOCUMENTATION, OR ANY PORTION OR COMPONENT OF THE PROGRAM OR ACCOMPANYING DOCUMENTATION; PROVIDED, HOWEVER, THAT YOU MAY TRANSFER THE ENTIRE PROGRAM AND ACCOMPANYING DOCUMENTATION ON A PERMANENT BASIS AS LONG AS YOU RETAIN NO COPIES (INCLUDING ARCHIVAL OR BACKUP COPIES) OF THE PROGRAM, ACCOMPANYING DOCUMENTATION, OR ANY PORTION OR COMPONENT OF THE PROGRAM OR ACCOMPANYING DOCUMENTATION, AND THE RECIPIENT AGREES TO THE TERMS OF THE AGREEMENT. FURTHER, YOU MAY NOT MODIFY, REVERSE ENGINEER, DISASSEMBLE, DECOMPILE OR TRANSLATE THE PROGRAM OR ACCOMPANYING DOCUMENTATION, OR ANY PORTION OR COMPONENT OF THE PROGRAM OR ACCOMPANYING DOCUMENTATION, NOR MAY YOU MAKE ANY COPIES OF THE PROGRAM MODULES FOR USE WITH OTHER PROGRAMS. THIS PROGRAM IS INTENDED FOR PRIVATE USE ONLY.

ROCKSTAR GAMES, A DIVISION OF TAKE-TWO INTERACTIVE SOFTWARE 575 BROADWAY 3RD FLOOR NEW YORK, NY 10012

## ESRB RATING

THIS PRODUCT HAS BEEN RATED BY THE ENTERTAINMENT SOFTWARE RATINGS BOARD. FOR INFORMATION ABOUT THE ESRB RATING, OR TO COMMENT ABOUT THE APPROPRIATENESS OF THE RATING, PLEASE CONTACT THE ESRB AT 1-800-771-3772.

Also Available from Rockstar Games...

# GTA2



Animated Violence  
Strong Language  
Suggestive Themes

Rockstar Games 575 Broadway 3rd Floor, New York, N.Y. 10012

Rockstar and the Rockstar Games logo are trademarks of Take-Two Interactive Software, Inc. © 2001. All Rights Reserved.

Licensed by Sony Computer Entertainment America for use with the PlayStation game console. PlayStation and the PlayStation logos are registered trademarks of Sony Computer Entertainment Inc. The ratings icon is a trademark of the Interactive Digital Software Association. Manufactured and printed in the U.S.A. THIS SOFTWARE IS COMPATIBLE WITH PLAYSTATION GAME CONSOLES WITH THE NTSC U/C DESIGNATION. U.S. AND FOREIGN PATENTS PENDING.

